

# HRS MRL

## PLANNING DATA

### General Technical Specification

<b>Rated Load (kg)</b>		<b>630</b>	<b>800</b>	<b>1000</b>	<b>1275</b>
<b>Passengers</b>		8	10	13	17
<b>Suspension</b>		2:1			
<b>Max Travel (m)</b>		120			
<b>Speed (m/s)</b>		2.0 / 2.5			
<b>Min. Pit (mm)</b>	2.0m/s	1800			
	2.5m/s	1950			
<b>Min. Headroom (mm)</b> (Ext. Cabin Height 2340mm)	2.0m/s	4450			4500
	2.5m/s	4700		4750	
<b>Max Empty Car Weight P(kg)</b>		1620	1380	1280	1490
<b>Guide rails (car)</b>		T90x75x16 Extra		T125x82x16 Extra	
<b>Guide rails (ctw)</b>		T75x62x10 Extra		T89x62x16 Extra	
<b>Brackets distance (mm)</b>		2000			
<b>Suspension ropes</b>		DRAKO Ø10 300T min Breaking load=66KN			
<b>Motor</b>		<b>ZIEHL-ABEGG</b>			
<b>Motor type</b>	2.0m/s	SM225.40B	SM225.40B	SM225.40B	SM225.40B / 60B
<b>Travel length (m)</b>		80 / 120	80 / 120	120	90 / 120
<b>Sheave-Number of ropes</b>		Φ400 4xΦ10 / 5xΦ10	Φ400 4xΦ10 / 5xΦ10	Φ400 5xΦ10	Φ400 5xΦ10
<b>Nominal power (KW)</b>		13	13	13	18.1 / 20
<b>(Nominal Current) (A)</b>		33	33	33	50 / 53.5
<b>Motor type</b>	2.5m/s	SM225.40B	SM225.40B	SM225.40B / 45C / 60B	SM225.60B
<b>Sheave-Number of ropes</b>		Φ400 4xΦ10 / 5xΦ10	Φ400 4xΦ10 / 5xΦ10	Φ400 5xΦ10	Φ400 6xΦ10
<b>Machine power (KW)</b>		15	15	15 / 22.6 / 25	25
<b>Nameplate Current (A)</b>		34	34	34 / 62.5 / 63	63
<b>Counterweight dbg (mm)</b>	2.0m/s	1000			1100
	2.5m/s	1000			1100

## FORCES ON SHAFT

### a. Forces on headroom walls

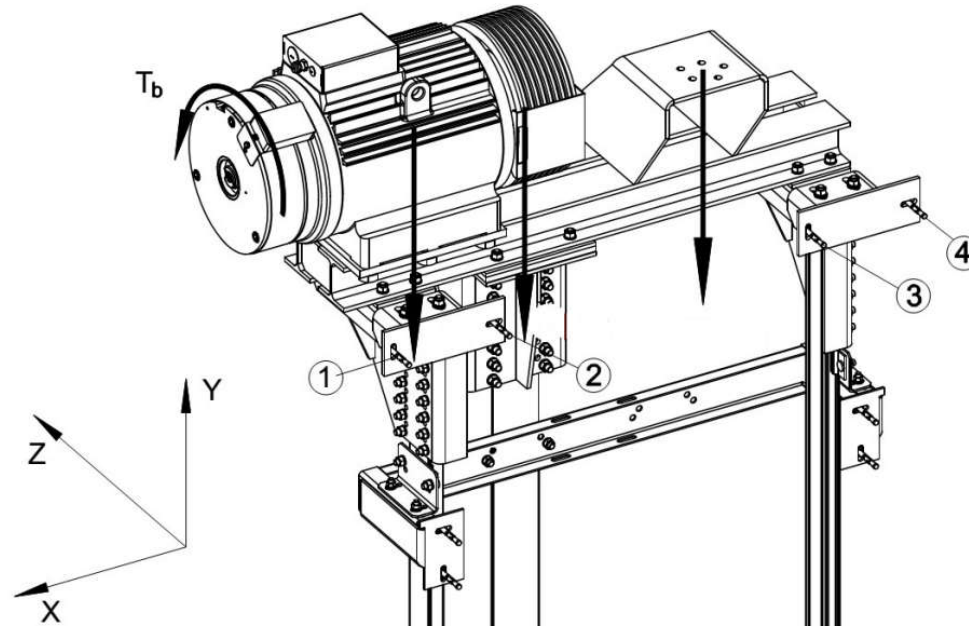

Rated Load [kg]	F1x [kN]	F1y [kN]	F1z [kN]	F2x [kN]	F2y [kN]	F2z [kN]	F3x [kN]	F3y [kN]	F3z [kN]	F4x [kN]	F4y [kN]	F3z [kN]
630	1.19	1.23	0.67	0.13	0.51	2.26	0.2	0.82	0.78	1.33	0.21	0.18
800	1.24	1.20	0.60	0.29	0.37	2.42	0.18	0.97	0.86	1.55	0.29	0.2
1000	1.67	1.9	1.12	0.11	1.07	3.02	0.34	0.92	1.01	1.55	0.15	0.24
1275	1.76	1.85	0.99	0.19	0.80	3.33	0.30	1.20	1.16	1.96	0.30	0.27

**b. Forces on pit floor**

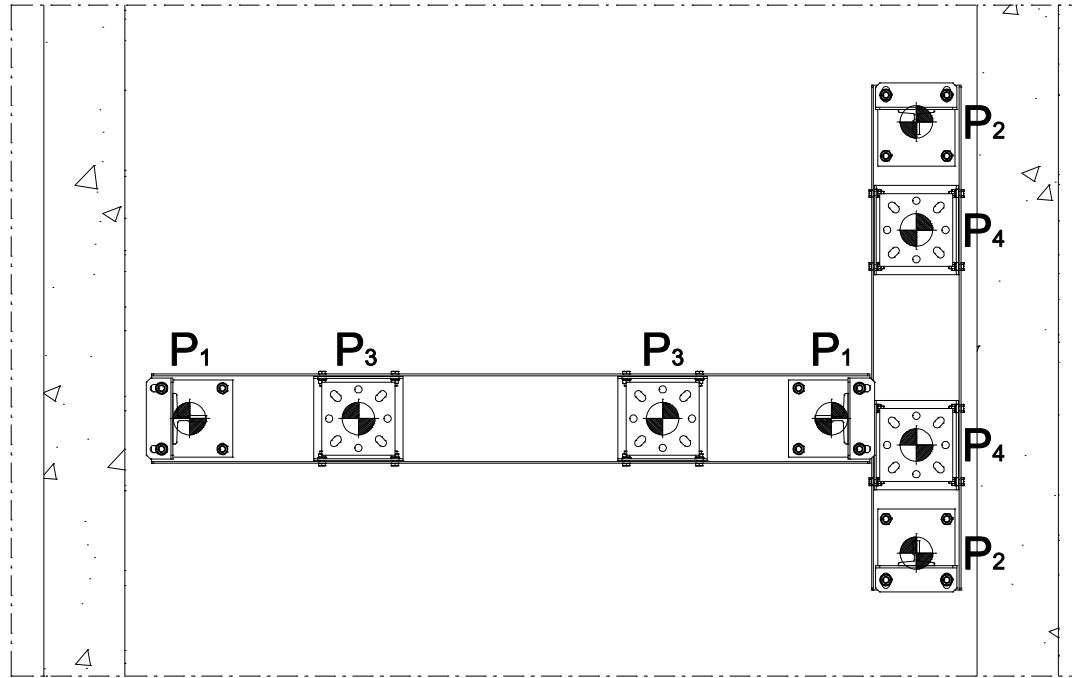

Rated Load [kg]	P <sub>1</sub> [kN]	P <sub>2</sub> [kN]	P <sub>3</sub> [kN]	P <sub>4</sub> [kN]
630	37.8	11.1	33.2	27
800	40.3	11.1	38.2	30.3
1000	48.1	15.4	42.8	33
1275	52.9	15.4	52.5	40

630kg / 8 persons / Available car area 1100x1400

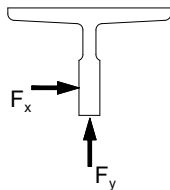
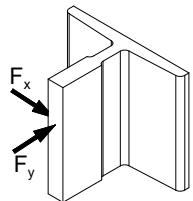
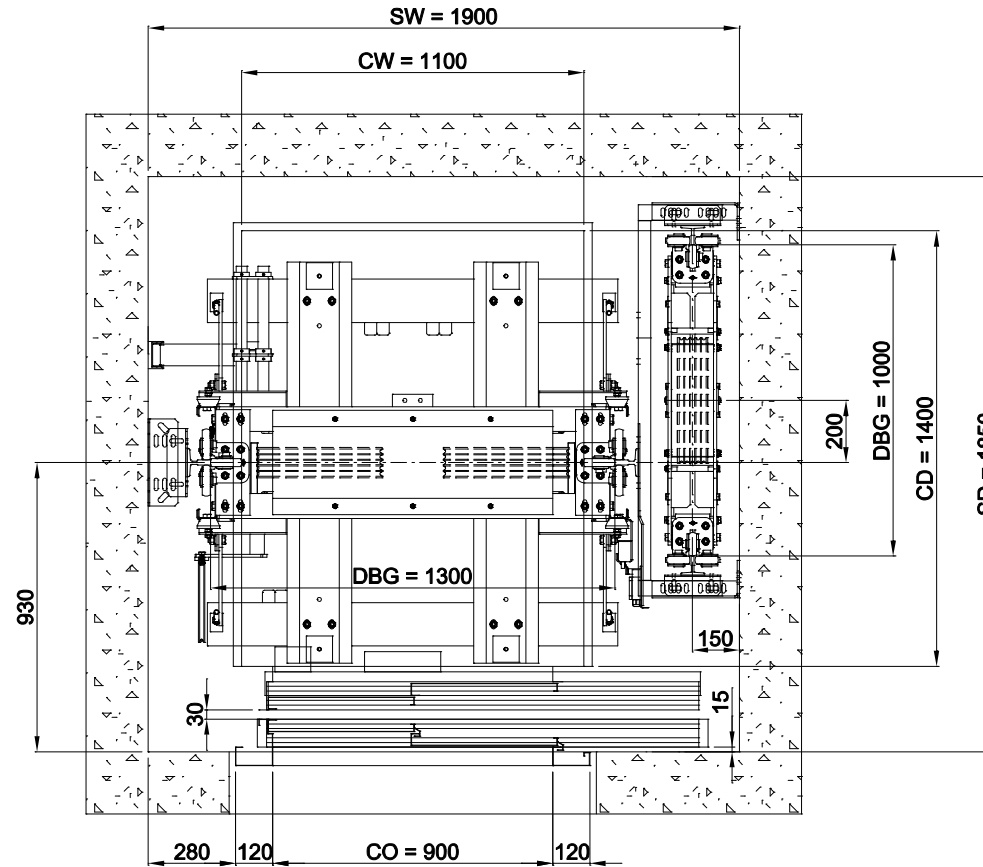

$F_x$	0.54 kN
$F_y$	0.46 kN

800kg / 10 persons / Available car area 1350x1400

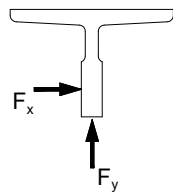
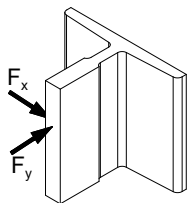
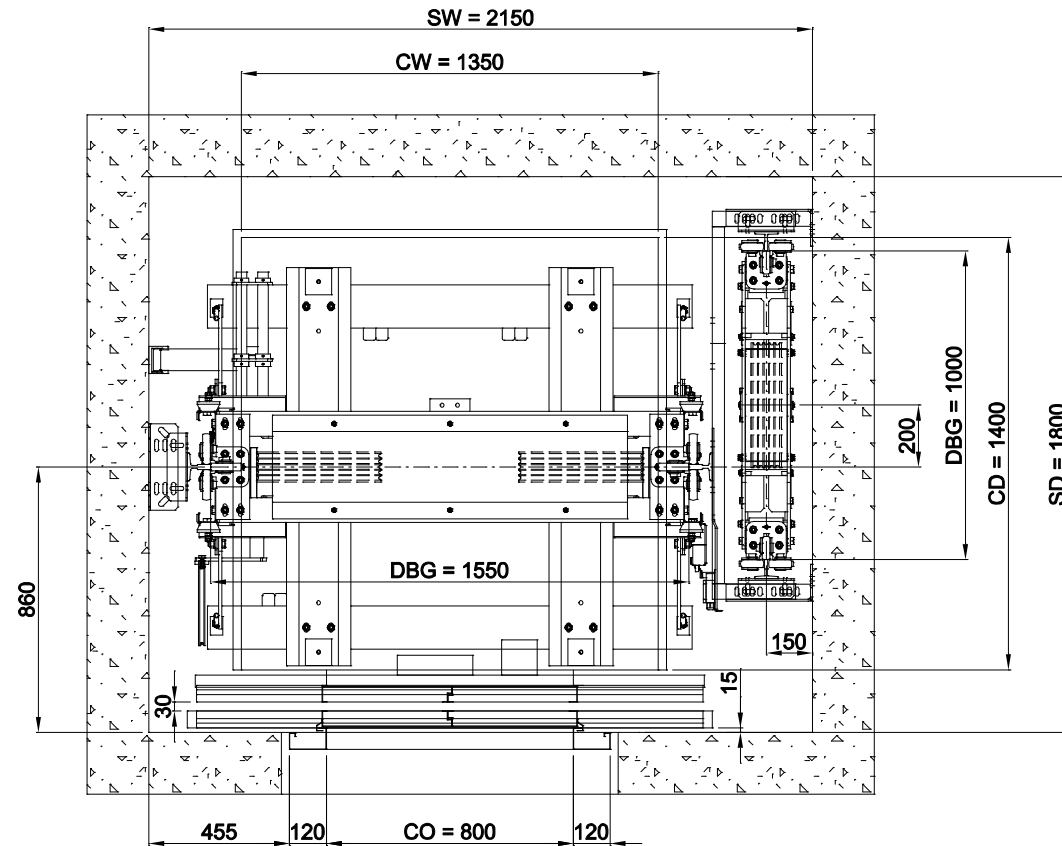

$F_x$	0.62 kN
$F_y$	0.71 kN

1000kg / 13 persons / Available car area 1100x2100

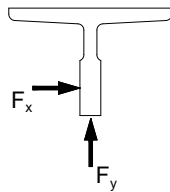
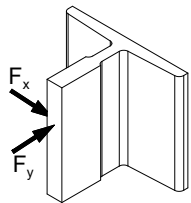
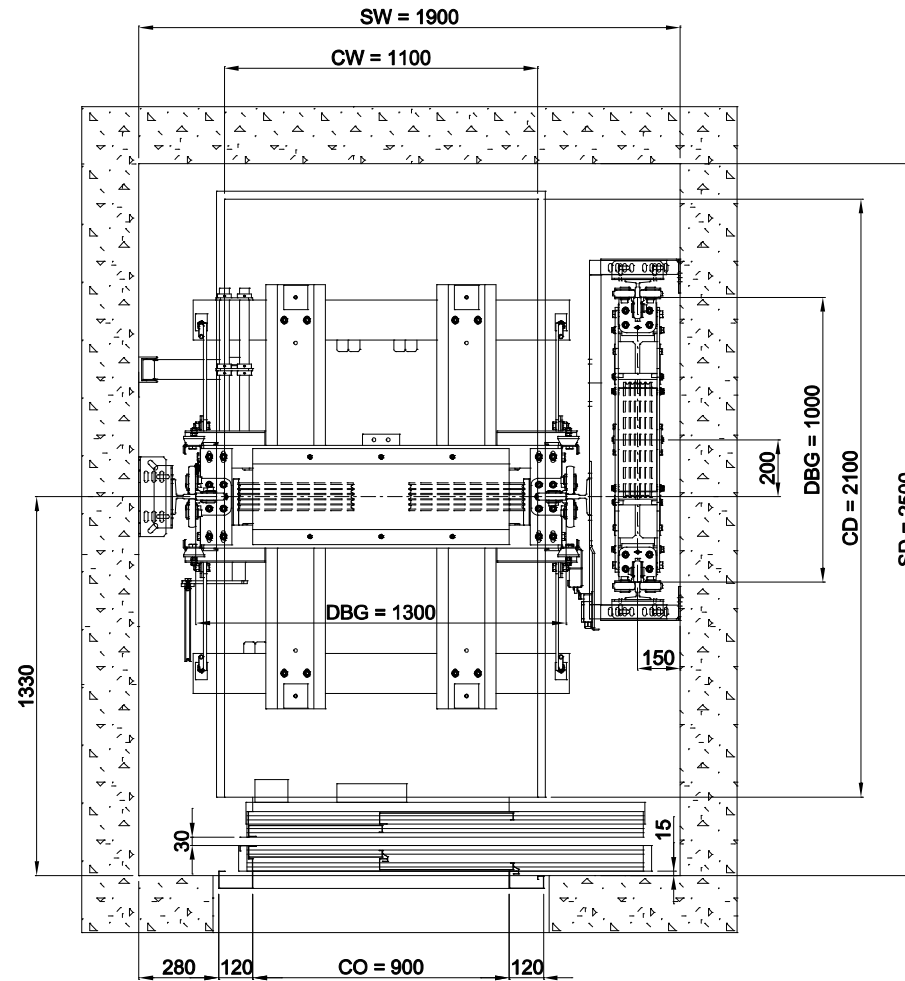

$F_x$	1.05 kN
$F_y$	0.72 kN

1000kg / 13 persons / Available car area 1100x2100 Through

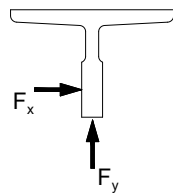
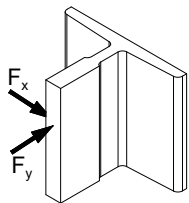
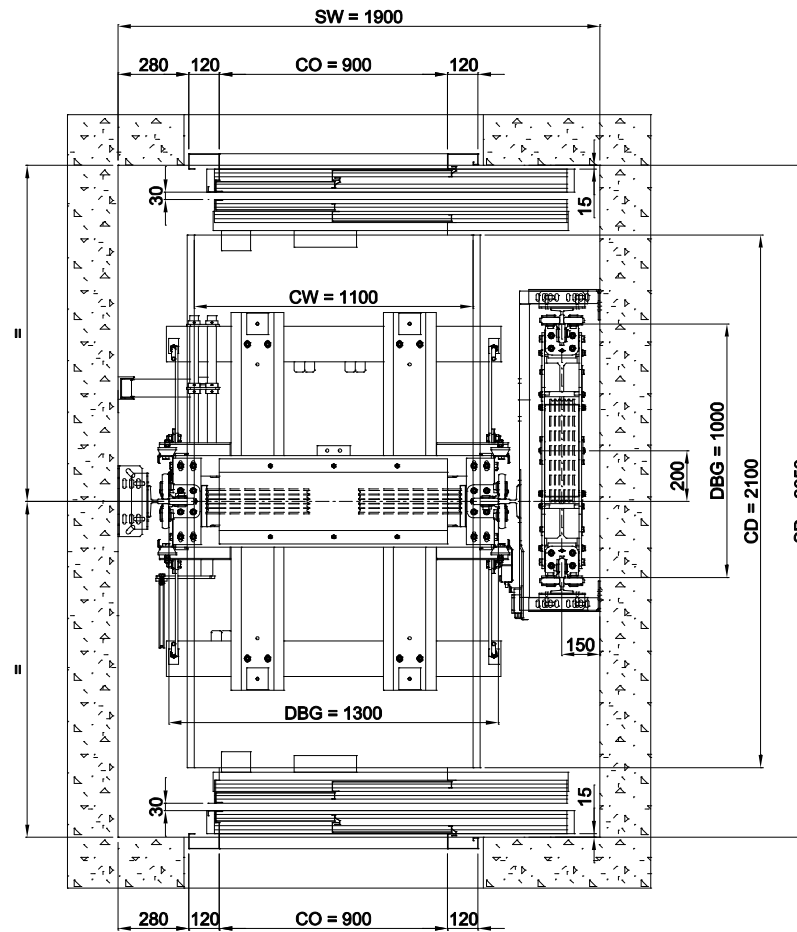

$F_x$	1.05 kN
$F_y$	0.72 kN

D-04-26-EN

All dimensions in mm  
Shaft tolerances:  $\pm 20$ mm

Version:01-25.05.2017

For special cases contact KLEEMANN Exports Department  
Subject to changes without prior notice



1275 kg / 17 persons / Available car area 1300x2100

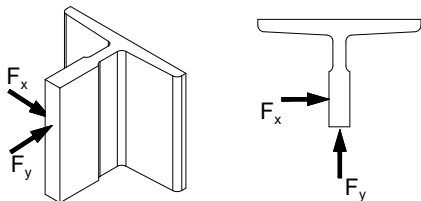
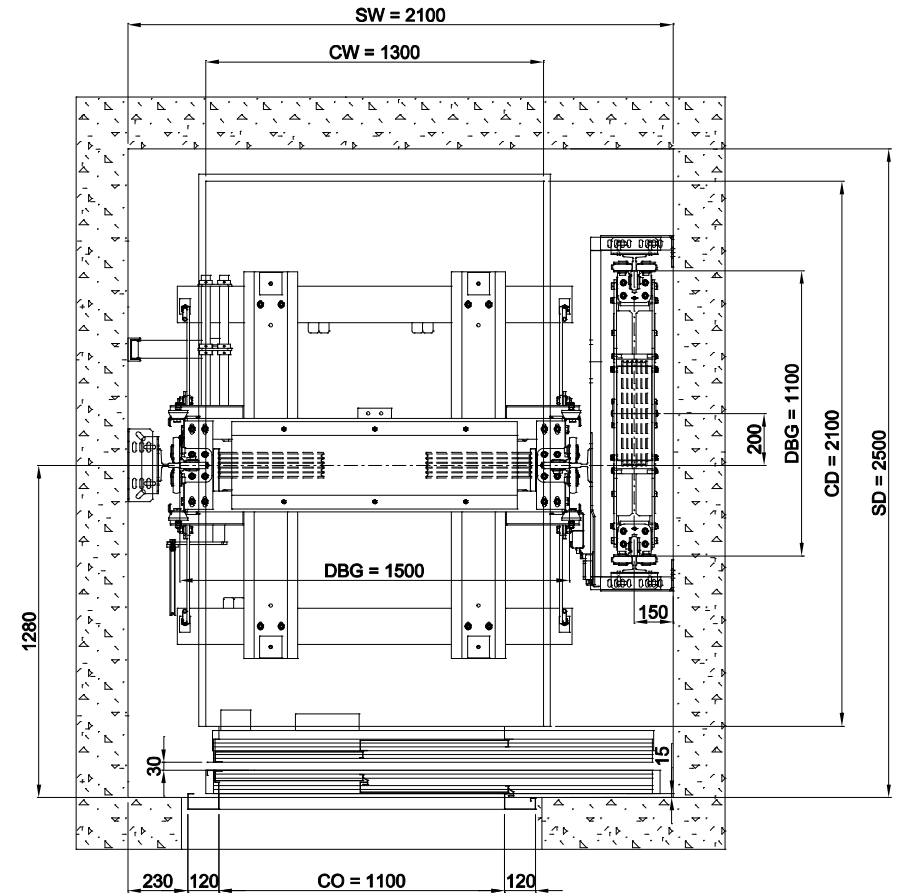
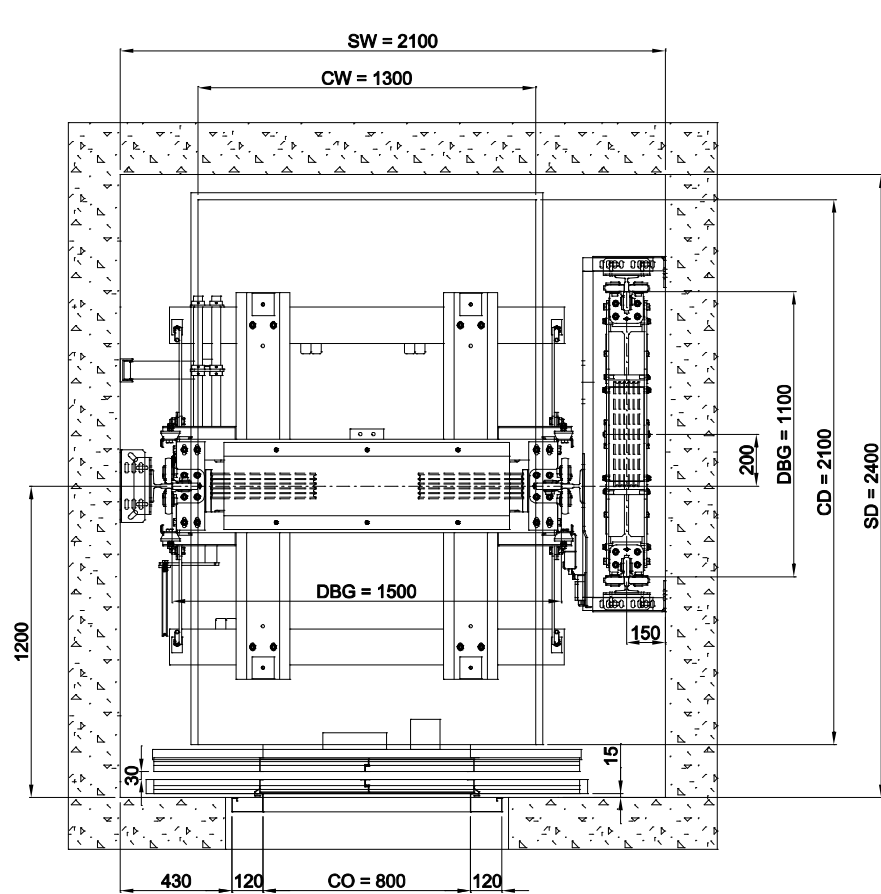

$F_x$	1.28 kN
$F_y$	1.09 kN

1275kg / 17 persons / Available car area 1100x2100 Through

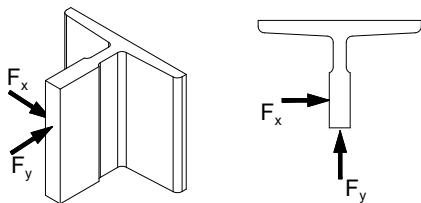
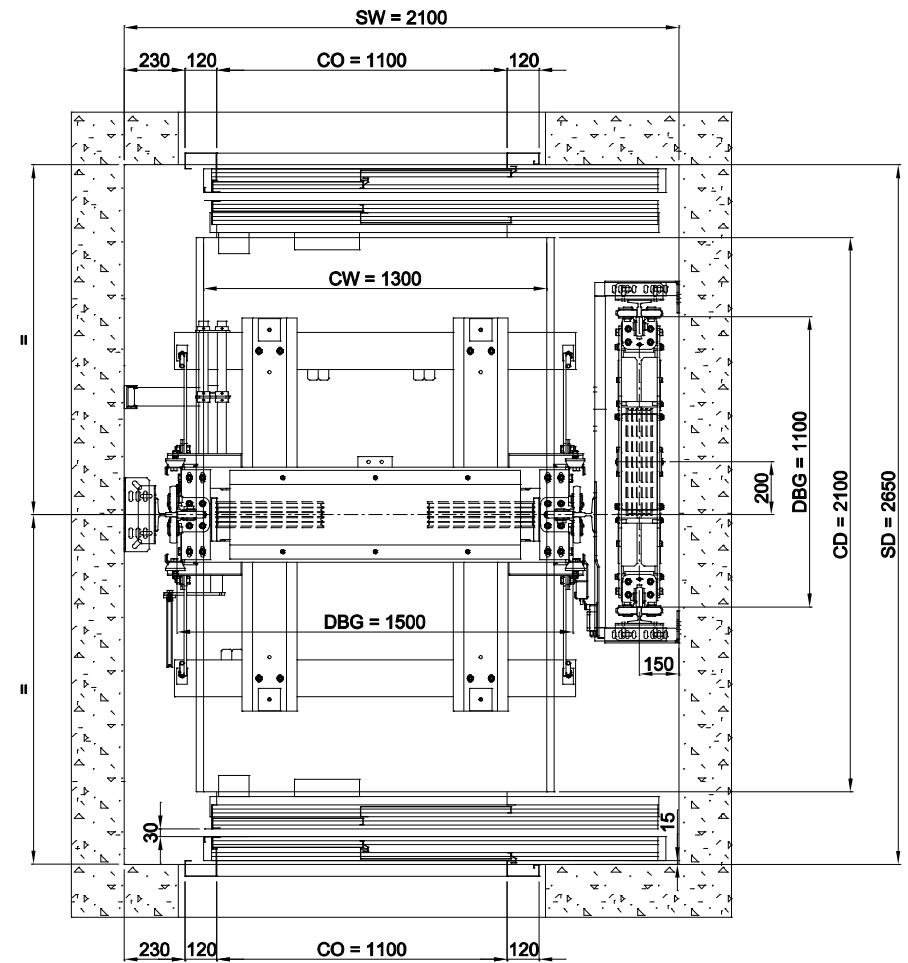
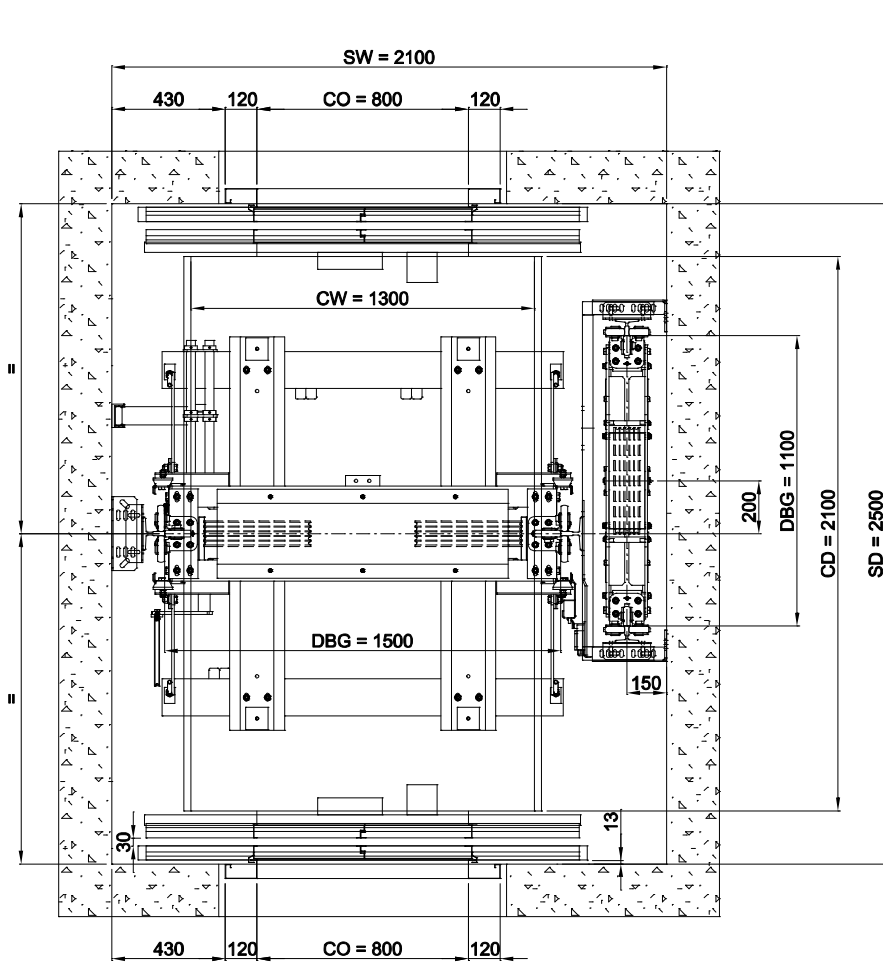

$F_x$	1.33 kN
$F_y$	1.09 kN

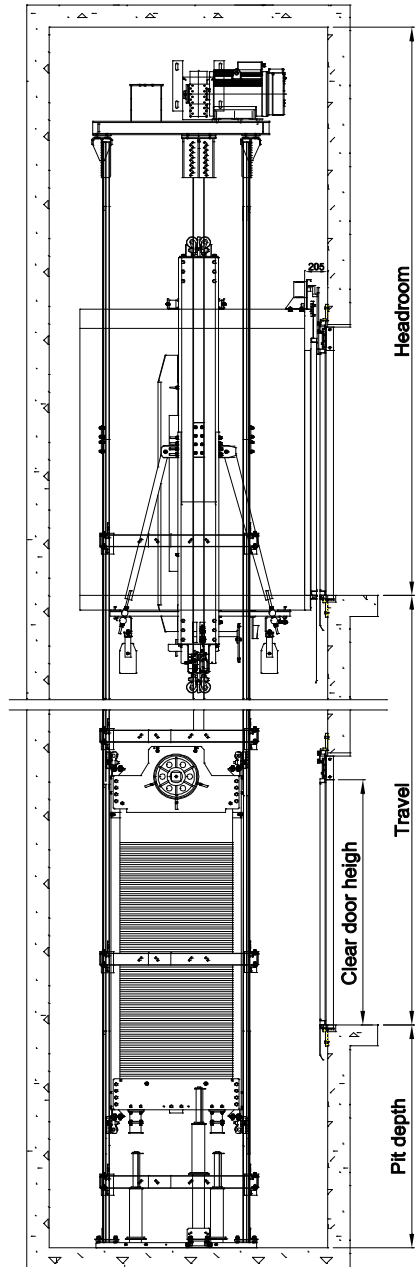

D-04-26-EN

Headroom (mm) Ziehl Abegg Machine			
Ext. Cabin Height (mm)	Rated Load (kg)	2.0m/s	2.5m/s
		min HD	min HD
2340	630	4450	4700
	800		
	1000	4500	4750
	1275		
2430	630	4550	4800
	800		
	1000	4600	4850
	1275		

Pit Depth (mm)	
2.0m/s	1800
2.5m/s	1950